

REPORT DE EXECUÇÃO DE PROJETOS DA BACIA HIDROGRÁFICA DO RIO SÃO FRANCISCO

Nº 01 | 30/08/2024

[Clique no mapa ao lado e navegue por região](#)

[Clique aqui para acessar os projetos que abrangem toda a bacia](#)

Report produzido e atualizado pelas Gerências de Integração e Projetos da Agência Peixe Vivo

TODA A BACIA DO SF

1. PROGRAMA DE COMUNICAÇÃO E RELACIONAMENTO INSTITUCIONAL
2. CAPACITAÇÃO IRRIGANTES DA BHSF
3. GERENCIAMENTO, FISCALIZAÇÃO, MEDIÇÃO E ACOMPANHAMENTO TÉCNICO DOS SERVIÇOS E OBRAS DO PROGRAMA DE SANEAMENTO RURAL
4. **EM BREVE NA BHSF**

SUBMÉDIO SÃO FRANCISCO

1. INSTALAÇÕES DE UNIDADE DE APOIO À EDUCAÇÃO AMBIENTAL E CAPACITAÇÃO DE POVOS TRADICIONAIS (UNEB), EM JEREMOABO (BA)
2. SOLUÇÕES INDIVIDUAIS DE TRATAMENTO DE EFLUENTES DOMÉSTICOS EM INHAPI (AL)
3. SOLUÇÕES INDIVIDUAIS DE TRATAMENTO DE EFLUENTES DOMÉSTICOS EM PARICONHA (AL)
4. SOLUÇÕES INDIVIDUAIS DE TRATAMENTO DE EFLUENTES DOMÉSTICOS EM JAGUARI (BA)
5. INSTALAÇÃO DE SISTEMAS FOTOVOLTAICOS NO SEMIÁRIDO, EM GLÓRIA (BA)
6. FISCALIZAÇÃO DE PROJETOS DE REQUALIFICAÇÃO AMBIENTAL NO MÉDIO E SUBMÉDIO SF
7. OBRAS DE REQUALIFICAÇÃO AMBIENTAL NA BACIA DO RIO PAJEÚ, EM FLORESTA (PE)
8. PIPs DO PROGRAMA DE PROTEÇÃO, CONSERVAÇÃO E RECUPERAÇÃO AMBIENTAL NO SUBMÉDIO E BAIXO SF
9. **EM BREVE NO SUBMÉDIO SÃO FRANCISCO**

ALTO SÃO FRANCISCO

1. PROPOSTA DE ENQUADRAMENTO DA BACIA DO RIO DAS VELHAS E DA BACIA DOS RIOS JEQUITAÍ-PACUÍ
2. FISCAL PARA ACOMPANHAMENTO DA PROPOSTA DE ENQUADRAMENTO DA BACIA DO RIO DAS VELHAS E DA BACIA DOS RIOS JEQUITAÍ-PACUÍ
3. PROPOSTA DE ENQUADRAMENTO DA BACIA DO RIO VERDE GRANDE
4. FISCAL PARA ACOMPANHAMENTO DA PROPOSTA DE ENQUADRAMENTO DA BACIA DO RIO VERDE GRANDE
5. SOLUÇÕES INDIVIDUAIS DE TRATAMENTO DE EFLUENTES EM JÁIBA (MG)
6. SOLUÇÕES INDIVIDUAIS DE TRATAMENTO DE EFLUENTES EM MAMONAS (MG)
7. SOLUÇÕES INDIVIDUAIS DE TRATAMENTO DE EFLUENTES EM PASSA TEMPO (MG)
8. FINANCIAMENTO DE SISTEMA DE ESGOTAMENTO COLETIVO EM JEQUITIBÁ (MG)
9. FINANCIAMENTO DE SISTEMA DE ESGOTAMENTO SANITÁRIO EM JOAQUIM FELÍCIO (MG)
10. FINANCIAMENTO DE SISTEMA DE ESGOTAMENTO SANITÁRIO EM BAMBUÍ (MG)
11. FINANCIAMENTO DE SISTEMA DE ESGOTAMENTO SANITÁRIO EM UNAI (MG)
12. FINANCIAMENTO DE SISTEMA DE ESGOTAMENTO SANITÁRIO EM CARMO DO CAJURU (MG)
13. FINANCIAMENTO DE SISTEMA DE ESGOTAMENTO SANITÁRIO EM PASSA TEMPO (MG)
14. TUBULAÇÃO DOS CANAIS PARA IRRIGAÇÃO NA BACIA DO RIO PRETO (DF)
15. INSUMO PARA CONTROLE DE VAZÃO E LONAMENTO DOS RESERVATÓRIOS NA BACIA DO RIO PRETO (DF)
16. PIPs DO PROGRAMA DE PROTEÇÃO, CONSERVAÇÃO E RECUPERAÇÃO AMBIENTAL EM MICROBACIA DO RIO SÃO FRANCISCO (ALTO E MÉDIO SF)
17. **EM BREVE NO ALTO SÃO FRANCISCO**

MÉDIO SÃO FRANCISCO

1. ESGOTAMENTO RURAL NO ENTORNO DA LAGOA DE ITAPARICA, EM XIQUE-XIQUE (BA)
2. SOLUÇÕES INDIVIDUAIS DE TRATAMENTO DE EFLUENTES DOMÉSTICOS EM LAPÃO (BA)
3. SOLUÇÕES INDIVIDUAIS DE TRATAMENTO DE EFLUENTES DOMÉSTICOS EM PARATINGA (BA)
4. SOLUÇÕES INDIVIDUAIS DE TRATAMENTO DE EFLUENTES DOMÉSTICOS EM JOÃO DOURADO (BA)
5. FINANCIAMENTO DE SISTEMA DE ESGOTAMENTO SANITÁRIO EM ÉRICO CARDOSO (BA)
6. FINANCIAMENTO DE SISTEMA DE ESGOTAMENTO SANITÁRIO EM CORRENTINA (BA)
7. LEVANTAMENTO DE USO DE RECURSOS HÍDRICOS NO RIO DE ONDAS, AFLUENTE DO RIO GRANDE (BA)
8. EXECUÇÃO DE SERVIÇOS DE REQUALIFICAÇÃO AMBIENTAL EM ITAGUAÇU DA BAHIA (BA)
9. ESTUDOS DA BIODIVERSIDADE NA BHSF
10. ASSESSORAMENTO NA EXECUÇÃO DE PROJETOS DE REQUALIFICAÇÃO AMBIENTAL NO MÉDIO SF
11. OBRAS DE REQUALIFICAÇÃO AMBIENTAL EM PARAMIRIM, ÉRICO CARDOSO E CATURAMA (BA)
12. OBRAS DE REQUALIFICAÇÃO AMBIENTAL NA BACIA DO RIO CORRENTE, EM CORRENTINA (BA)
13. FISCALIZAÇÃO DOS PROJETOS DE REQUALIFICAÇÃO AMBIENTAL NO MÉDIO E SUBMÉDIO SF
14. PIPs DO PROGRAMA DE PROTEÇÃO, CONSERVAÇÃO E RECUPERAÇÃO AMBIENTAL EM MICROBACIA DO RIO SÃO FRANCISCO (ALTO E MÉDIO SF)
15. **EM BREVE NO MÉDIO SÃO FRANCISCO**

BAIXO SÃO FRANCISCO

1. PROJETO ARQUITETÔNICO BÁSICO E EXECUTIVO DO MUSEU CASA DO VELHO CHICO, TRAIPU (AL)
2. ELABORAÇÃO DE PROJETO BÁSICO E EXECUTIVO PARA INTERVENÇÕES NA CENTRAL DE TRIAGEM E UNIDADE DE TRANSBORDO DE PROPRIÁ – CONBASE
3. ELABORAÇÃO DE PROJETO BÁSICO E EXECUTIVO PARA GALPÕES DE TRIAGEM E PÁTIOS DE COMPOSTAGEM – CONBASE
4. EXECUÇÃO DE OBRAS E SERVIÇOS PARA A INTERLIG. DE REDE DE ESGOTO EM PENEDO (AL)
5. ASSESSORAMENTO TÉCNICO NA FISCALIZAÇÃO DE OBRA DE REDE DE ESGOTO EM PENEDO (AL)
6. SOLUÇÕES INDIVIDUAIS DE TRATAMENTO DE EFLUENTES DOMÉSTICOS EM TRAIPU (AL)
7. SOLUÇÕES INDIVIDUAIS DE TRATAMENTO DE EFLUENTES DOMÉSTICOS EM SANTANA DO IPANEMA (AL)
8. SOLUÇÕES INDIVIDUAIS DE TRATAMENTO DE EFLUENTES DOM. EM PEDRO ALEXANDRE (BA)
9. AEROLEVANTAMENTO A LASER NO RIO SÃO FRANCISCO, DE PAULO AFONSO À FOZ
10. MACRODRENAGEM EM ESTRADAS VICINAIS NA ALDEIA XOKÓ, PORTO DA FOLHA (SE)
11. ASSESSORAMENTO TÁC. FISCALIZAÇÃO DE OBRA DE MELHORIAS DA MACRODRENAGEM NA ALDEIA XOKÓ, PORTO DA FOLHA (SE)
12. PIPs DO PROGRAMA DE PROTEÇÃO, CONSERVAÇÃO E RECUPERAÇÃO AMBIENTAL NO SUBMÉDIO E BAIXO SF
13. **EM BREVE NO BAIXO SÃO FRANCISCO**



A seguir você encontrará informações sobre os projetos executados pela Agência Peixe Vivo na bacia hidrográfica do rio São Francisco, financiados com recursos oriundos da cobrança pelo uso dos recursos hídricos.

O objetivo desse Report é apresentar um panorama dos projetos, destacando os resultados alcançados e as próximas etapas.

Aqui são destacados os projetos em andamento, os que foram recentemente concluídos e uma prévia das iniciativas futuras.

Outros informações sobre os projetos aqui apresentados podem ser acessadas no SIGA SÃO FRANCISCO, por meio do link

<https://siga.cbhsaofrancisco.org.br/acomp-acoes.html>

TODA A BACIA DO SF



EIXO 1

GOVERNANÇA E
MOBILIZAÇÃO
SOCIAL



PROGRAMA DE COMUNICAÇÃO E RELACIONAMENTO INSTITUCIONAL



LOCAL DE EXECUÇÃO
TODA A BACIA HIDROGRÁFICA



EMPRESA CONTRATADA
TANTO COMUNICAÇÃO LTDA



DATA DO INÍCIO DA EXECUÇÃO (OS)
01/04/2022



VALOR GLOBAL DO CONTRATO
R\$ 6.576.150,49



DURAÇÃO DO PROJETO
36 MESES



VALOR EXECUTADO ATÉ AGOSTO/24
R\$ 4.344.679,69



NÚMERO DO CONTRATO
011/2022



PRÓXIMAS ETAPAS
Produção e veiculação de vídeo, produção
de podcast, assessoria continuada



FISCAL TÉCNICO APV
DANIEL BRITO



**PERCENTUAL
DE EXECUÇÃO**

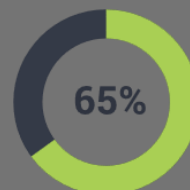

TODA A BACIA DO SF



EIXO

1

GOVERNANÇA E
MOBILIZAÇÃO
SOCIAL



ELABORAÇÃO E REALIZAÇÃO DE CAPACITAÇÃO PARA MANEJO DA IRRIGAÇÃO NA BACIA HIDROGRÁFICA DO RIO SÃO FRANCISCO



LOCAL DE EXECUÇÃO
TODA A BACIA HIDROGRÁFICA



EMPRESA CONTRATADA
ÁGUA E SOLO ESTUDOS E PROJETOS LTDA



DATA DO INÍCIO DA EXECUÇÃO (OS)
30/05/2023



VALOR GLOBAL DO CONTRATO
R\$ 1.074.687,38



DURAÇÃO DO PROJETO
20 MESES



VALOR EXECUTADO ATÉ AGOSTO
R\$ 1.074.687,38



NÚMERO DO CONTRATO
015/2023



PRÓXIMAS ETAPAS
Finalizado



FISCAL TÉCNICO APV
MANOEL VIEIRA



PERCENTUAL
DE EXECUÇÃO

100%



TODA A BACIA DO SF



EIXO 2

QUALIDADE DA ÁGUA E SANEAMENTO



GERENCIAMENTO, FISCALIZAÇÃO, MEDIÇÃO E ACOMPANHAMENTO TÉCNICO DOS SERVIÇOS E OBRAS DO PROGRAMA DE SANEAMENTO RURAL



LOCAL DE EXECUÇÃO
TODA A BACIA HIDROGRÁFICA



EMPRESA CONTRATADA
HIDROBR CONSULTORIA LTDA



DATA DO INÍCIO DA EXECUÇÃO (OS)
11/06/2024



VALOR GLOBAL DO CONTRATO
R\$ 1.741.827,36



DURAÇÃO DO PROJETO
20 MESES



VALOR EXECUTADO ATÉ AGOSTO
R\$ 104.509,64



NÚMERO DO CONTRATO
014/2024

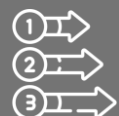

PRÓXIMAS ETAPAS
PRODUTO 2



FISCAL TÉCNICO APV
GUILHERME CARVALHO



PERCENTUAL DE EXECUÇÃO

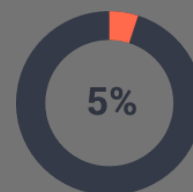



EM TODA A BACIA HIDROGRÁFICA DO RIO SÃO FRANCISCO

1. PROGRAMA DE EDUCAÇÃO AMBIENTAL DA BACIA HIDROGRÁFICA DO RIO SÃO FRANCISCO
2. MOBILIZAÇÃO SOCIAL PARA APOIO À REALIZAÇÃO DO PROCESSO ELEITORAL DO COMITÊ DA BACIA HIDROGRÁFICA DO RIO SÃO FRANCISCO – CBHSF



PROPOSTA DE ENQUADRAMENTO DA BACIA DO RIO DAS VELHAS E DA BACIA DOS RIOS JEQUITAÍ-PACUÍ



LOCAL DE EXECUÇÃO

BACIA DO RIO DAS VELHAS (SF5)
BACIA DOS RIOS JEQUITAÍ-PACUÍ (SF6)



DATA DO INÍCIO DA EXECUÇÃO (OS)

10/08/2023



DURAÇÃO DO PROJETO

19 MESES



NÚMERO DO CONTRATO

020/2022



FISCAL TÉCNICO APV
JOÃO PAULO COIMBRA



EMPRESA CONTRATADA

ECOPLAN ENGENHARIA LTDA



VALOR GLOBAL DO CONTRATO

R\$ 1.659.445,18



VALOR EXECUTADO ATÉ AGOSTO/24

R\$ 580.805,81



PRÓXIMAS ETAPAS

Proposta de metas e alternativas de
Enquadramento e programa de efetivação

PERCENTUAL
DE EXECUÇÃO



ALTO SÃO FRANCISCO



EIXO 1

GOVERNANÇA E
MOBILIZAÇÃO
SOCIAL



FISCAL PARA ACOMPANHAMENTO DA PROPOSTA DE ENQUADRAMENTO DA BACIA DO RIO DAS VELHAS E DA BACIA DOS RIOS JEQUITAÍ-PACUÍ



LOCAL DE EXECUÇÃO

BACIA DO RIO DAS VELHAS (SF5)
BACIA DOS RIOS JEQUITAÍ-PACUÍ (SF6)



FISCAL CONTRATADO

PEDRO LUCAS COSMO DE BRITO



DATA DO INÍCIO DA EXECUÇÃO (OS)

10/08/2023



VALOR GLOBAL DO CONTRATO

R\$ 113.798,74



DURAÇÃO DO PROJETO

19 MESES



VALOR EXECUTADO ATÉ AGOSTO/24

R\$ 45.519,52



NÚMERO DO CONTRATO

027/2022



PRÓXIMAS ETAPAS

Proposta de metas e alternativas de
Enquadramento e programa de efetivação



FISCAL TÉCNICO APV
JOÃO PAULO COIMBRA



PERCENTUAL
DE EXECUÇÃO

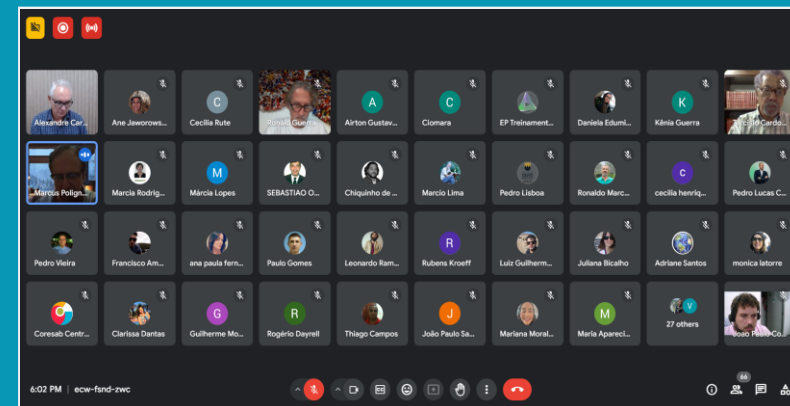

ALTO SÃO FRANCISCO



EIXO 1

GOVERNANÇA E
MOBILIZAÇÃO
SOCIAL

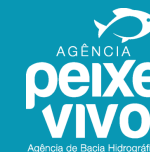

PROPOSTA DE ENQUADRAMENTO DA BACIA DO RIO VERDE GRANDE



LOCAL DE EXECUÇÃO
BACIA DO RIO VERDE GRANDE
(SF10 E RPGA XXV)



EMPRESA CONTRATADA
ENGEORPS ENGENHARIA SA



DATA DO INÍCIO DA EXECUÇÃO (OS)
15/04/2024



VALOR GLOBAL DO CONTRATO
R\$ 1.102.913,00



DURAÇÃO DO PROJETO
15 MESES



VALOR EXECUTADO ATÉ AGOSTO/24
R\$ 110.291,30



NÚMERO DO CONTRATO
010/2024



PRÓXIMAS ETAPAS
PROPOSTA DE METAS E ALTERNATIVAS
DE ENQUADRAMENTO E PROGRAMA
DE EFETIVAÇÃO



FISCAL TÉCNICO APV
JOÃO PAULO COIMBRA



**PERCENTUAL
DE EXECUÇÃO**



ALTO SÃO FRANCISCO



EIXO 1

GOVERNANÇA E
MOBILIZAÇÃO
SOCIAL

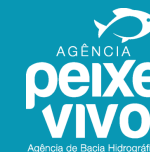

FISCAL PARA ACOMPANHAMENTO DA PROPOSTA DE ENQUADRAMENTO DA BACIA DO RIO VERDE GRANDE



LOCAL DE EXECUÇÃO
BACIA DO RIO VERDE GRANDE
(SF10 E RPGA XXV)



FISCAL CONTRATADO
ANDRÉ LUIZ BONACIN SILVA



DATA DO INÍCIO DA EXECUÇÃO (OS)
19/08/2024



VALOR GLOBAL DO CONTRATO
R\$ 68.400,00



DURAÇÃO DO PROJETO
12 MESES



VALOR EXECUTADO ATÉ AGOSTO/24
R\$ 0,00



NÚMERO DO CONTRATO
041/2024



PRÓXIMAS ETAPAS
INICIAR TRATATIVAS E
CONTEXTUALIZAR O FISCAL



FISCAL TÉCNICO APV
JOÃO PAULO COIMBRA



**PERCENTUAL
DE EXECUÇÃO**

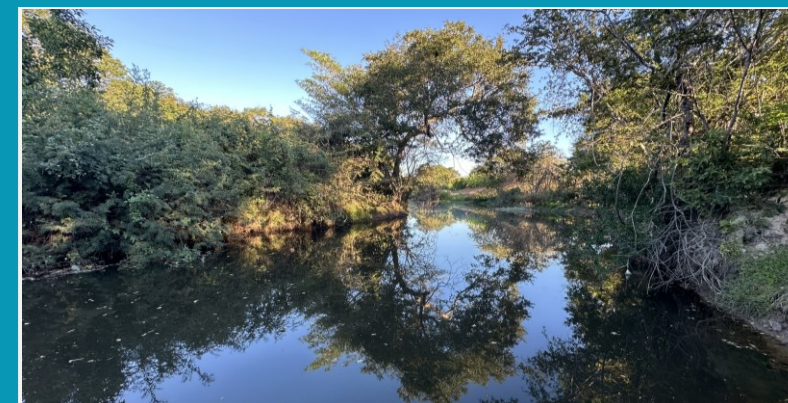
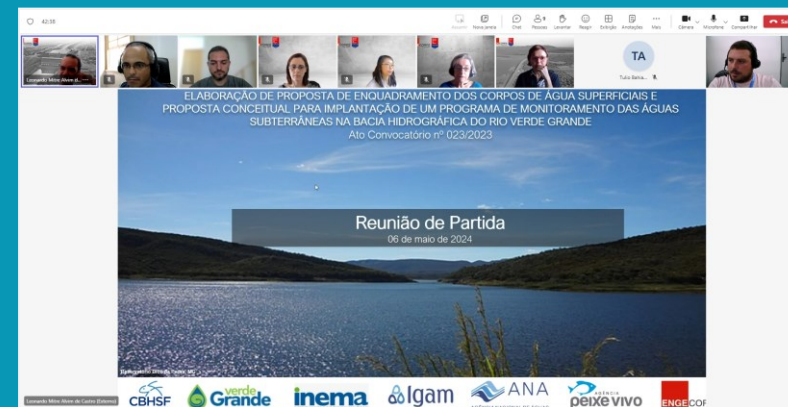

ALTO SÃO FRANCISCO



EIXO 2

QUALIDADE
DA ÁGUA E
SANEAMENTO



EXECUÇÃO DE SOLUÇÕES INDIVIDUAIS DE TRATAMENTO DE EFLUENTES DOMÉSTICOS NO MUNICÍPIO DE JAÍBA/MG



LOCAL DE EXECUÇÃO
COMUNIDADE DE TAMBORIL,
JAÍBA (MG)



EMPRESA CONTRATADA
CONSTRUTORA JOAMAR LTDA.



DATA DO INÍCIO DA EXECUÇÃO (OS)
15/07/2024



VALOR GLOBAL DO CONTRATO
R\$ 717.896,59



DURAÇÃO DO PROJETO
05 MESES



VALOR EXECUTADO ATÉ AGOSTO
EXPECTATIVA DE MEDIÇÃO DE
60 MIL REAIS EM AGOSTO



NÚMERO DO CONTRATO
030/2024



PRÓXIMAS ETAPAS
MEDIÇÃO SERÁ REALIZADA EM AGOSTO



FISCAL TÉCNICO APV
GUILHERME CARVALHO



**PERCENTUAL
DE EXECUÇÃO**

0%





EXECUÇÃO DE SOLUÇÕES INDIVIDUAIS DE TRATAMENTO DE EFLUENTES DOMÉSTICOS NO MUNICÍPIO DE MAMONAS/MG



LOCAL DE EXECUÇÃO
LOCALIDADE VÁRZEA DA CONCEIÇÃO,
MAMONAS (MG)



EMPRESA CONTRATADA
CONSTRUTORA JOAMAR LTDA.



DATA DO INÍCIO DA EXECUÇÃO (OS)
15/07/2024



VALOR GLOBAL DO CONTRATO
R\$ 1.239.410,91



DURAÇÃO DO PROJETO
07 MESES



VALOR EXECUTADO ATÉ AGOSTO
EXPECTATIVA DE MEDIÇÃO DE
60 MIL REAIS EM AGOSTO



NÚMERO DO CONTRATO
031/2024



PRÓXIMAS ETAPAS
MEDIÇÃO SERÁ REALIZADA EM AGOSTO



FISCAL TÉCNICO APV
GUILHERME CARVALHO



**PERCENTUAL
DE EXECUÇÃO**

0%



ALTO SÃO FRANCISCO



EIXO 2

QUALIDADE
DA ÁGUA E
SANEAMENTO

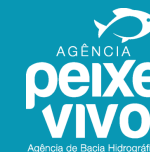

EXECUÇÃO DE SOLUÇÕES INDIVIDUAIS DE TRATAMENTO DE EFLUENTES DOMÉSTICOS NO MUNICÍPIO DE PASSA TEMPO/MG



LOCAL DE EXECUÇÃO

LOCALIDADE CACHOEIRA DOS FORROS,
PASSA TEMPO (MG)



DATA DO INÍCIO DA EXECUÇÃO (OS)

31/07/2024



DURAÇÃO DO PROJETO

08 MESES



NÚMERO DO CONTRATO

034/2024



FISCAL TÉCNICO APV
GUILHERME CARVALHO



EMPRESA CONTRATADA
MAIS AMBIENTE ENGENHARIA



VALOR GLOBAL DO CONTRATO

R\$ 1.672.618,90



VALOR EXECUTADO ATÉ AGOSTO

0,00



PRÓXIMAS ETAPAS
MEDIÇÃO EM SETEMBRO

PERCENTUAL
DE EXECUÇÃO

0%





FINANCIAMENTO A FUNDO PERDIDO PARA A EXECUÇÃO DO SISTEMA DE ESGOTAMENTO SANITÁRIO DE JEQUITIBÁ/MG



LOCAL DE EXECUÇÃO
JEQUITIBÁ (MG)



EMPRESA CONTRATADA
DACT ENGENHARIA LTDA
(FISCALIZADA PELA PREFEITURA
DE JEQUITIBÁ /MG)



DATA DO INÍCIO DA EXECUÇÃO (OS)
NÃO SE APLICA



VALOR GLOBAL DO CONTRATO
R\$ 4.982.000,00 – REPASSADO APV
R\$ 318.000,00 – CONTRAPARTIDA
PREFEITURA



DURAÇÃO DO PROJETO
12 MESES



VALOR EXECUTADO ATÉ AGOSTO
R\$ 127.623,95



NÚMERO DO CONTRATO
050/2023



PRÓXIMAS ETAPAS
REALIZADA 2ª MEDIÇÃO DA OBRA



FISCAL TÉCNICA APV
JACQUELINE FONSECA



**PERCENTUAL
DE EXECUÇÃO**

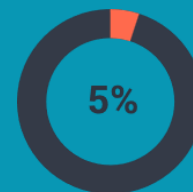



FINANCIAMENTO A FUNDO PERDIDO PARA A EXECUÇÃO DO SISTEMA DE ESGOTAMENTO SANITÁRIO DE JOAQUIM FELÍCIO/MG



LOCAL DE EXECUÇÃO
JOAQUIM FELÍCIO (MG)



EMPRESA CONTRATADA
AGUARDANDO LICITAÇÃO



DATA DO INÍCIO DA EXECUÇÃO (OS)
NÃO SE APLICA



VALOR GLOBAL DO CONTRATO
R\$ 6.860.000,00 – REPASSADO APV
R\$ 140.000,00 CONTRAPARTIDA
PREFEITURA



DURAÇÃO DO PROJETO
12 MESES



VALOR EXECUTADO ATÉ AGOSTO
R\$ 0,00



NÚMERO DO CONTRATO
049/2023



PRÓXIMAS ETAPAS
1 APROVAÇÃO DA DOCUMENTAÇÃO
2 TÉCNICA PELA CEF



FISCAL TÉCNICA APV
JACQUELINE FONSECA



PERCENTUAL
DE EXECUÇÃO

0%





FINANCIAMENTO A FUNDO PERDIDO PARA A EXECUÇÃO DO SISTEMA DE ESGOTAMENTO SANITÁRIO DE BAMBUÍ/MG



LOCAL DE EXECUÇÃO
BAMBUÍ (MG)



EMPRESA CONTRATADA
AGUARDANDO LICITAÇÃO



DATA DO INÍCIO DA EXECUÇÃO (OS)
NÃO SE APLICA



VALOR GLOBAL DO CONTRATO
R\$ 13.500.000,00 – REPASSADO APV
R\$ 500.000,00 – CONTRAPARTIDA
PREFEITURA



DURAÇÃO DO PROJETO
12 MESES



VALOR EXECUTADO ATÉ AGOSTO
R\$ 0,00



NÚMERO DO CONTRATO
051/2023



PRÓXIMAS ETAPAS
AUTORIZAÇÃO DE LICITAÇÃO EMITIDA



FISCAL TÉCNICA APV
JACQUELINE FONSECA



PERCENTUAL
DE EXECUÇÃO

0%





FINANCIAMENTO A FUNDO PERDIDO PARA A EXECUÇÃO DO SISTEMA DE ESGOTAMENTO SANITÁRIO DE UNAÍ/MG



LOCAL DE EXECUÇÃO
UNAÍ (MG)



EMPRESA CONTRATADA
AGUARDANDO LICITAÇÃO



DATA DO INÍCIO DA EXECUÇÃO (OS)
NÃO SE APLICA



VALOR GLOBAL DO CONTRATO
R\$ 6.241.941,15 - REPASSADO APV
R\$ 506.103,34 – CONTRAPARTIDA
PREFEITURA



DURAÇÃO DO PROJETO
12 MESES



VALOR EXECUTADO ATÉ AGOSTO
R\$ 0,00



NÚMERO DO CONTRATO
052/2023



PRÓXIMAS ETAPAS
1 APROVAÇÃO DA DOCUMENTAÇÃO
TÉCNICA PELA CEF



FISCAL TÉCNICA APV
JACQUELINE FONSECA



PERCENTUAL
DE EXECUÇÃO

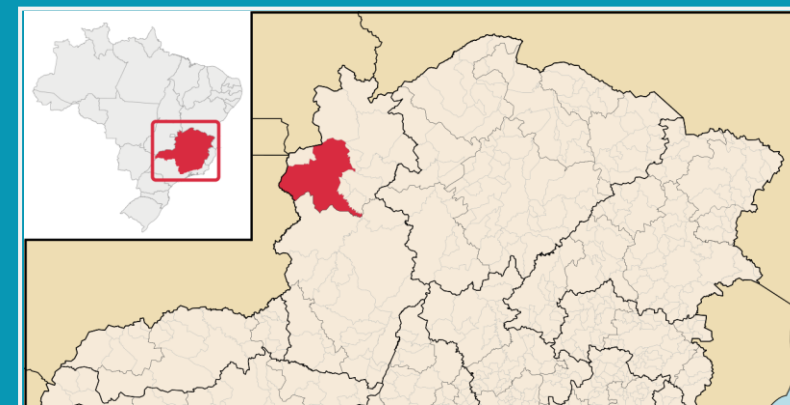



FINANCIAMENTO A FUNDO PERDIDO PARA A AMPLIAÇÃO DO SISTEMA DE ESGOTAMENTO SANITÁRIO DE CARMO DO CAJURU/MG



LOCAL DE EXECUÇÃO
CARMO DO CAJURU (MG)



EMPRESA CONTRATADA
AGUARDANDO LICITAÇÃO



DATA DO INÍCIO DA EXECUÇÃO (OS)
NÃO SE APLICA



VALOR GLOBAL DO CONTRATO
R\$ 6.800.331,13 - REPASSADO APV
R\$ 138.782,27 – CONTRAPARTIDA
PREFEITURA



DURAÇÃO DO PROJETO
12 MESES



VALOR EXECUTADO ATÉ AGOSTO
R\$ 0,00



NÚMERO DO CONTRATO
017/2024



PRÓXIMAS ETAPAS
1. APROVAÇÃO DA DOCUMENTAÇÃO
TÉCNICA PELA CEF



FISCAL TÉCNICA APV
JACQUELINE FONSECA



PERCENTUAL DE EXECUÇÃO



ALTO SÃO FRANCISCO



EIXO 2

QUALIDADE DA ÁGUA E SANEAMENTO

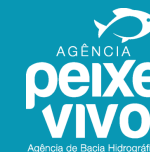

FINANCIAMENTO A FUNDO PERDIDO PARA A EXECUÇÃO DO SISTEMA DE ESGOTAMENTO SANITÁRIO DE PASSA TEMPO/MG



LOCAL DE EXECUÇÃO
PASSA TEMPO (MG)



EMPRESA CONTRATADA
AGUARDANDO LICITAÇÃO



DATA DO INÍCIO DA EXECUÇÃO (OS)
NÃO SE APLICA



VALOR GLOBAL DO CONTRATO
R\$ 5.441.700,00 - REPASSADO APV
R\$ 168.300,00 – CONTRAPARTIDA
PREFEITURA



DURAÇÃO DO PROJETO
12 MESES



VALOR EXECUTADO ATÉ AGOSTO
R\$ 0,00



NÚMERO DO CONTRATO
018/2024



PRÓXIMAS ETAPAS
1 APROVAÇÃO DA DOCUMENTAÇÃO
TÉCNICA PELA CEF



FISCAL TÉCNICA APV
JACQUELINE FONSECA



PERCENTUAL
DE EXECUÇÃO



ALTO SÃO FRANCISCO



EIXO 3

QUANTIDADE DE
ÁGUA E USOS
MÚLTIPLOS



AQUISIÇÃO DE INSUMOS PARA A REALIZAÇÃO DA TUBULAÇÃO DOS CANAIS EM TERRA PARA IRRIGAÇÃO NA BACIA DO RIO PRETO - DF



LOCAL DE EXECUÇÃO
BACIA HIDROGRÁFICA DO
ALTO RIO PRETO



EMPRESA CONTRATADA
EDEX COMERCIAL GOIÁS ATACADISTA DE
MATERIAIS DE CONSTRUÇÃO LTDA - ME



DATA DO INÍCIO DA EXECUÇÃO (OS)
19/06/2024



VALOR GLOBAL DO CONTRATO
R\$ 2.851.134,74



DURAÇÃO DO PROJETO
03 MESES



VALOR EXECUTADO ATÉ AGOSTO
EXPECTATIVA DE MEDIÇÃO
EM AGOSTO DE 2.5 MILHÃO



NÚMERO DO CONTRATO
021/2029



PRÓXIMAS ETAPAS
MEDIÇÃO NO FIM DE AGOSTO



FISCAL TÉCNICO APV
THIAGO LANA



**PERCENTUAL
DE EXECUÇÃO**

0%



ALTO SÃO FRANCISCO



EIXO 3

QUANTIDADE DE
ÁGUA E USOS
MÚLTIPLOS

COMITÊ DA BACIA HIDROGRÁFICA
DO RIO SÃO FRANCISCO

AGÊNCIA
peixe
vivo
Agência de Bacia Hidrográfica

AQUISIÇÃO DE INSUMOS PARA O CONTROLE DE VAZÃO DOS CANAIS REVESTIDOS E LONAMENTO DOS RESERVATÓRIOS ESCAVADOS NA BACIA DO RIO PRETO-DF



LOCAL DE EXECUÇÃO
BACIA HIDROGRÁFICA DO ALTO RIO PRETO



EMPRESA CONTRATADA
J. ARMANDO AGUIAR & CIA LTDA.



DATA DO INÍCIO DA EXECUÇÃO (OS)
03/07/2024



VALOR GLOBAL DO CONTRATO
R\$ 2.656.669,70



DURAÇÃO DO PROJETO
02 MESES



VALOR EXECUTADO ATÉ AGOSTO
R\$ 0,00 MILHÃO



NÚMERO DO CONTRATO
027/2024



PRÓXIMAS ETAPAS
SOLDAS E MONTAGEM
NO GABARITO DOS TANQUES



FISCAL TÉCNICO APV
THIAGO LANA



**PERCENTUAL
DE EXECUÇÃO**

0%

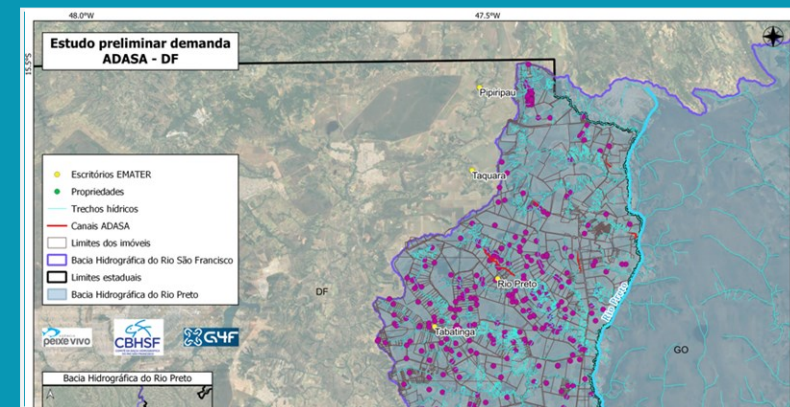

ALTO SÃO FRANCISCO



EIXO 5

BIODIVERSIDADE
E REQUALIFICAÇÃO
AMBIENTAL

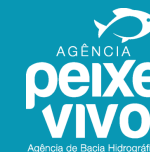

PROJETOS INDIVIDUAIS POR PROPRIEDADE DO PROGRAMA DE PROTEÇÃO, CONSERVAÇÃO E RECUPERAÇÃO AMBIENTAL EM MICROBACIA DO RIO SÃO FRANCISCO – ALTO SF E MÉDIO SF



LOCAL DE EXECUÇÃO

Januária, Caetanópolis e Paraopeba (MG)



EMPRESA CONTRATADA
EMBAÚBA AMBIENTAL LTDA



DATA DO INÍCIO DA EXECUÇÃO (OS)

28/08/2024



VALOR GLOBAL DO CONTRATO

R\$ 1.956.708,73



DURAÇÃO DO PROJETO

14 MESES



VALOR EXECUTADO ATÉ AGOSTO

R\$ 0,00



NÚMERO DO CONTRATO

046/2024



PRÓXIMAS ETAPAS

DIAGNÓSTICO DAS MICROBASIAS E
BASES DE DADOS GEOGRÁFICOS



FISCAL TÉCNICA APV
PAULO SÉRGIO



PERCENTUAL
DE EXECUÇÃO





NO ALTO SÃO FRANCISCO

1. ENQUADRAMENTO DAS BACIAS HIDROGRÁFICAS DOS RIOS PARACATU, URUCUIA E CARINHANHA
2. FISCAL PARA ENQUADRAMENTO DAS BACIAS HIDROGRÁFICAS DOS RIOS PARACATU, URUCUIA E CARINHANHA

MÉDIO SÃO FRANCISCO



EIXO 2

QUALIDADE
DA ÁGUA E
SANEAMENTO



ELABORAÇÃO DE PROJETOS DE SOLUÇÕES INDIVIDUAIS DE ESGOTAMENTO SANITÁRIO EM COMUNIDADES RURAIS NO ENTORNO DA LAGOA DE ITAPARICA, EM XIQUE-XIQUE/BA



LOCAL DE EXECUÇÃO
XIQUE-XIQUE E GENTIO DO OURO (BA)



EMPRESA CONTRATADA
DHF CONSULTORIA E ENGENHARIA LTDA



DATA DO INÍCIO DA EXECUÇÃO (OS)
16/02/2024



VALOR GLOBAL DO CONTRATO
R\$ 341.673,13



DURAÇÃO DO PROJETO
08 MESES



VALOR EXECUTADO ATÉ AGOSTO
R\$ 153.752,91



NÚMERO DO CONTRATO
001/2024



PRÓXIMAS ETAPAS
ELABORAÇÃO DOS PROJETOS
EXECUTIVOS



FISCAL TÉCNICA APV
FLÁVIA MENDES



**PERCENTUAL
DE EXECUÇÃO**



MÉDIO SÃO FRANCISCO



EIXO 2

QUALIDADE
DA ÁGUA E
SANEAMENTO



EXECUÇÃO DE SOLUÇÕES INDIVIDUAIS DE TRATAMENTO DE EFLUENTES DOMÉSTICOS NO MUNICÍPIO DE LAPÃO/BA



LOCAL DE EXECUÇÃO
COMUNIDADE DE VOLTA GRANDE,
LAPÃO/BA



EMPRESA CONTRATADA
CONSTRUTORA JOAMAR LTDA



DATA DO INÍCIO DA EXECUÇÃO (OS)
NÃO EMITIDA



VALOR GLOBAL DO CONTRATO
R\$ 2.549.362,02



DURAÇÃO DO PROJETO
07 MESES



VALOR EXECUTADO ATÉ AGOSTO
R\$ 0,00



NÚMERO DO CONTRATO
047/2024



PRÓXIMAS ETAPAS
EMISSÃO DE OS



FISCAL TÉCNICO APV
GUILHERME CARVALHO



**PERCENTUAL
DE EXECUÇÃO**



MÉDIO SÃO FRANCISCO



EIXO 2

QUALIDADE
DA ÁGUA E
SANEAMENTO



EXECUÇÃO DE PROJETOS DE ENGENHARIA DE SOLUÇÕES INDIVIDUAIS DE TRATAMENTO DE EFLUENTES DOMÉSTICOS NO MUNICÍPIO DE PARATINGA/BA



LOCAL DE EXECUÇÃO
COMUNIDADE DE POÇÃO
DE SANTO ANTÔNIO



EMPRESA CONTRATADA
APLICAR ENGENHARIA LTDA



DATA DO INÍCIO DA EXECUÇÃO (OS)
NÃO EMITIDA



VALOR GLOBAL DO CONTRATO
R\$ 1.917.206,32



DURAÇÃO DO PROJETO
08 MESES



VALOR EXECUTADO ATÉ AGOSTO
R\$ 0,00



NÚMERO DO CONTRATO
048/2024



PRÓXIMAS ETAPAS
EMISSÃO DE OS



FISCAL TÉCNICO APV
GUILHERME CARVALHO



**PERCENTUAL
DE EXECUÇÃO**



MÉDIO SÃO FRANCISCO



EIXO 2

QUALIDADE
DA ÁGUA E
SANEAMENTO



EXECUÇÃO DE SOLUÇÕES INDIVIDUAIS DE TRATAMENTO DE EFLUENTES DOMÉSTICOS NO MUNICÍPIO DE JOÃO DOURADO/BA



LOCAL DE EXECUÇÃO
COMUNIDADE DE MATA DO MILHO



EMPRESA CONTRATADA
CONSTRUTORA JOAMAR LTDA



DATA DO INÍCIO DA EXECUÇÃO (OS)
NÃO EMITIDA



VALOR GLOBAL DO CONTRATO
R\$ 3.647.265,28



DURAÇÃO DO PROJETO
07 MESES



VALOR EXECUTADO ATÉ AGOSTO
R\$ 0,00



NÚMERO DO CONTRATO
049/2024



PRÓXIMAS ETAPAS
EMISSÃO DE OS



FISCAL TÉCNICO APV
GUILHERME CARVALHO



PERCENTUAL
DE EXECUÇÃO

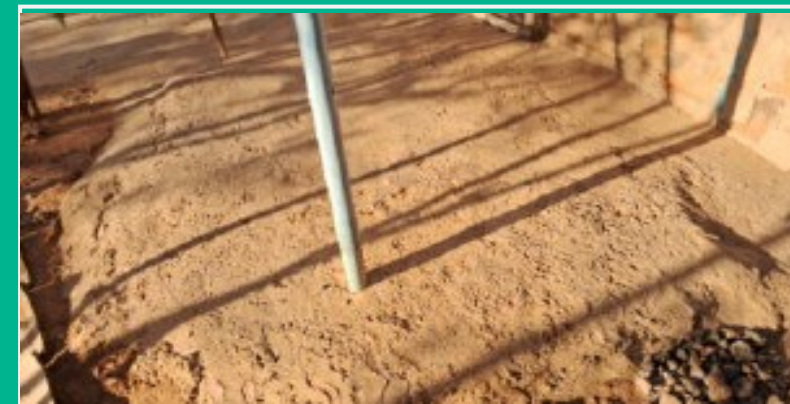

MÉDIO SÃO FRANCISCO



EIXO 2

QUALIDADE
DA ÁGUA E
SANEAMENTO

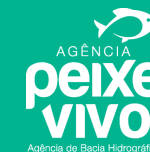

FINANCIAMENTO A FUNDO PERDIDO PARA A EXECUÇÃO DO SISTEMA DE ESGOTAMENTO SANITÁRIO DE ÉRICO CARDOSO/BA



LOCAL DE EXECUÇÃO
ERICO CARDOSO/BA



EMPRESA CONTRATADA
AGUARDANDO LICITAÇÃO



DATA DO INÍCIO DA EXECUÇÃO (OS)
NÃO SE APLICA



VALOR GLOBAL DO CONTRATO
R\$ 3.699.573,33 – REPASSE APV PREVISTO
R\$ 5.000.000,00 – CONTRAPARTIDA DA
PREFEITURA PREVISTA



DURAÇÃO DO PROJETO
12 MESES



VALOR EXECUTADO ATÉ AGOSTO
R\$ 0,00



NÚMERO DO CONTRATO
02/2024



PRÓXIMAS ETAPAS
CONTRATO SUSPENSO – AGUARDANDO
PAGAMENTO DA CONTRAPARTIDA



FISCAL TÉCNICO APV
JACQUELINE FONSECA



**PERCENTUAL
DE EXECUÇÃO**

0%

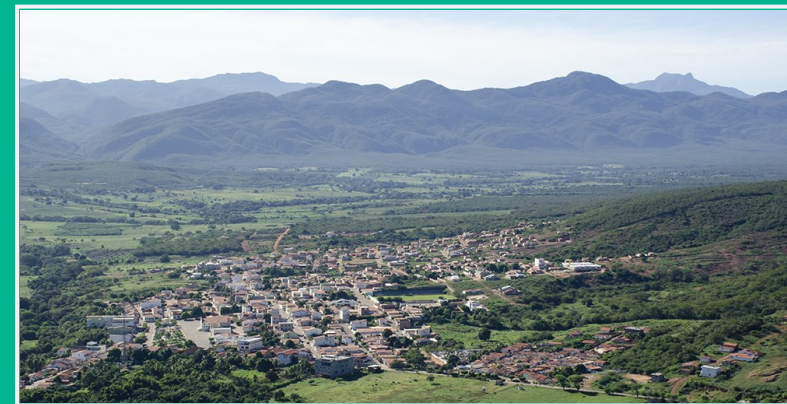

MÉDIO SÃO FRANCISCO



EIXO 2

QUALIDADE
DA ÁGUA E
SANEAMENTO



FINANCIAMENTO A FUNDO PERDIDO PARA A EXECUÇÃO DO SISTEMA DE ESGOTAMENTO SANITÁRIO DE CORRENTINA/BA



LOCAL DE EXECUÇÃO
CORRENTINA/BA



EMPRESA CONTRATADA
AGUARDANDO LICITAÇÃO



DATA DO INÍCIO DA EXECUÇÃO (OS)
NÃO SE APLICA



VALOR GLOBAL DO CONTRATO
R\$ 12.270.123,18 – REPASSE APV
R\$ 250.410,68 – CONTRAPARTIDA
PREFEITURA



DURAÇÃO DO PROJETO
12 MESES



VALOR EXECUTADO ATÉ AGOSTO
R\$ 0,00



NÚMERO DO CONTRATO
03/2024



PRÓXIMAS ETAPAS
1 APROVAÇÃO DA DOCUMENTAÇÃO
TÉCNICA PELA CEF



FISCAL TÉCNICO APV
JACQUELINE FONSECA



PERCENTUAL
DE EXECUÇÃO

0%



MÉDIO SÃO FRANCISCO



EIXO 3

QUANTIDADE DE
ÁGUA E USOS
MÚLTIPLOS

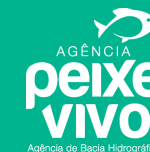

LEVANTAMENTO DE USOS DE RECURSOS HÍDRICOS NO RIO DE ONDAS, AFLUENTE DO RIO GRANDE, BAHIA, POR MEIO DE AEROFOTOGRAFIA E PERFILAMENTO A LASER



LOCAL DE EXECUÇÃO
RIO DE ONDAS (BA)



EMPRESA CONTRATADA
SERVIÇOS AÉREOS INDUSTRIAIS
ESPECIALIZADOS LTDA



DATA DO INÍCIO DA EXECUÇÃO (OS)
11/03/2024



VALOR GLOBAL DO CONTRATO
R\$ 396.500,00



DURAÇÃO DO PROJETO
08 MESES



VALOR EXECUTADO ATÉ AGOSTO
R\$ 317.200,00



NÚMERO DO CONTRATO
007/2024



PRÓXIMAS ETAPAS
ELABORAÇÃO DO RELATÓRIO
FINAL



FISCAL TÉCNICA APV
FLÁVIA MENDES



PERCENTUAL
DE EXECUÇÃO

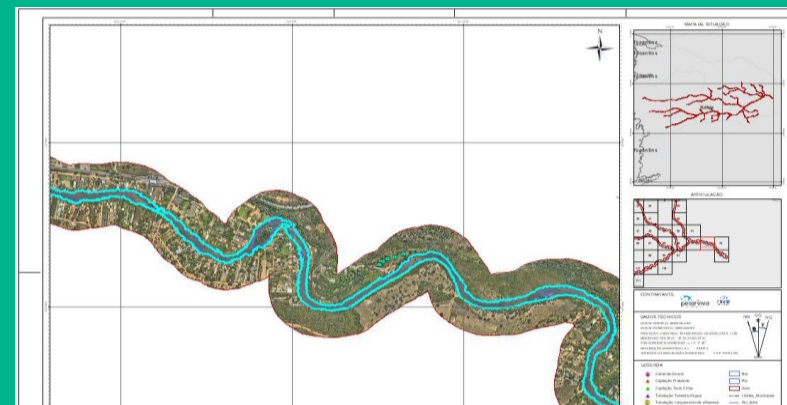
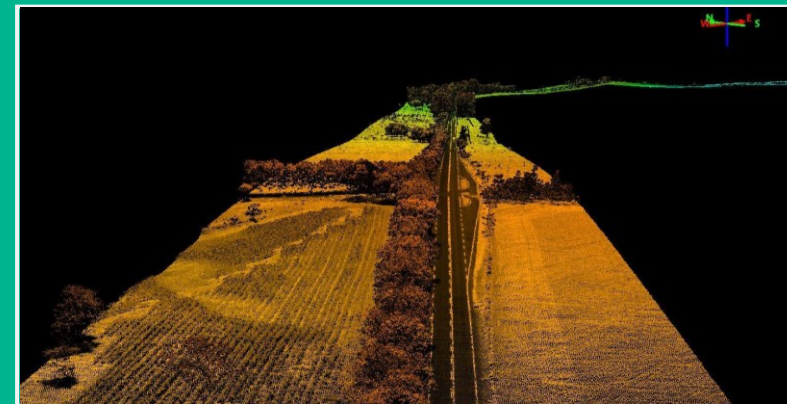
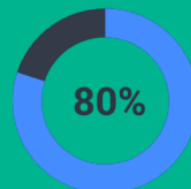

MÉDIO SÃO FRANCISCO



EIXO 4

SUSTENTABILIDADE HÍDRICA NO SEMIÁRIDO



EXECUÇÃO DE SERVIÇOS DE REQUALIFICAÇÃO AMBIENTAL EM ITAGUAÇU DA BAHIA/BA



LOCAL DE EXECUÇÃO
ITAGUAÇU DA BAHIA



EMPRESA CONTRATADA
W2 ENGENHARIA LTDA



DATA DO INÍCIO DA EXECUÇÃO (OS)
05/07/2022



VALOR GLOBAL DO CONTRATO
R\$ 704.679,75



DURAÇÃO DO PROJETO
34 MESES (1º ADITIVO DE PRAZO)



VALOR EXECUTADO ATÉ AGOSTO
R\$ 526.595,56



NÚMERO DO CONTRATO
035/2022



PRÓXIMAS ETAPAS
MEDIÇÃO 14



FISCAL TÉCNICO APV
GUILHERME CARVALHO



PERCENTUAL
DE EXECUÇÃO

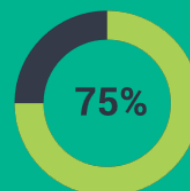

MÉDIO SÃO FRANCISCO



EIXO

5

BIODIVERSIDADE
E REQUALIFICAÇÃO
AMBIENTAL



ESTUDOS TÉCNICOS PARA DETERMINAR O ESTADO DE CONSERVAÇÃO DA BIODIVERSIDADE NA BACIA HIDROGRÁFICA DO RIO SÃO FRANCISCO



LOCAL DE EXECUÇÃO

APA LAGOA ITAPARICA, APA DUNAS E VEREDAS DO BAIXO-MÉDIO SF (BA)



EMPRESA CONTRATADA

ECOSSISTEMA CONSULTORIA AMBIENTAL LTDA.



DATA DO INÍCIO DA EXECUÇÃO (OS)

03/09/2024



VALOR GLOBAL DO CONTRATO

R\$ 728.091,90



DURAÇÃO DO PROJETO

06 MESES



VALOR EXECUTADO ATÉ AGOSTO

R\$ 0,00



NÚMERO DO CONTRATO

029/2024



PRÓXIMAS ETAPAS

Emissão da OS



FISCAL TÉCNICO APV
PRISCILA USHIMARU



PERCENTUAL
DE EXECUÇÃO

0%

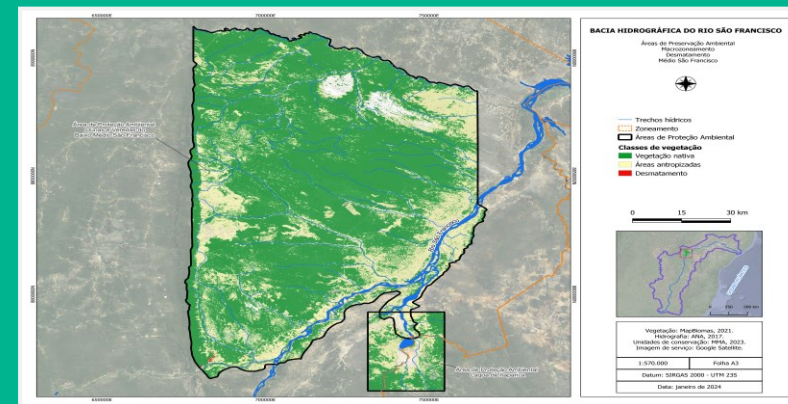

MÉDIO SÃO FRANCISCO



EIXO 5

BIODIVERSIDADE E REQUALIFICAÇÃO AMBIENTAL



CONTRATAÇÃO DE SERVIÇOS DE CONSULTORIA PARA ASSESSORAMENTO TÉCNICO NA EXECUÇÃO DE PROJETOS DE REQUALIFICAÇÃO AMBIENTAL NO MÉDIO SÃO FRANCISCO



LOCAL DE EXECUÇÃO

BARRA DO MENDES, MULUNGU DO MORRO, ITAGUAÇU DA BAHIA E PARAMIRIM (BA)



CONSULTOR CONTRATADO

HUGO LEONARDO FREIRE



DATA DO INÍCIO DA EXECUÇÃO (OS)

05/07/2022



VALOR GLOBAL DO CONTRATO

R\$ 263.678,22



DURAÇÃO DO PROJETO

31 MESES (1º ADITIVO DE PRAZO)



VALOR EXECUTADO ATÉ AGOSTO

R\$ 210.181,49



NÚMERO DO CONTRATO

034/2022



PRÓXIMAS ETAPAS

RELATÓRIO DE FISCALIZAÇÃO 24



FISCAL TÉCNICO APV

PAULO SÉRGIO



PERCENTUAL DE EXECUÇÃO



Figura 14: Gráfico de desembolso (acumulado) previsto e realizado do projeto de requalificação ambiental em Paramirim, Érico Cardoso e Caturama/BA



MÉDIO SÃO FRANCISCO

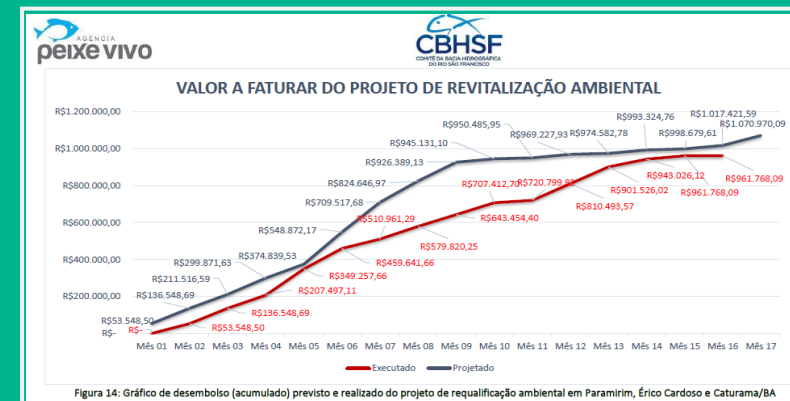
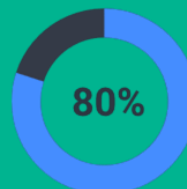

EIXO 5

BIODIVERSIDADE
E REQUALIFICAÇÃO
AMBIENTAL



CONTRATAÇÃO DE PESSOA JURÍDICA PARA EXECUÇÃO DAS OBRAS E SERVIÇOS DE REQUALIFICAÇÃO AMBIENTAL NOS MUNICÍPIOS DE PARAMIRIM, ÉRICO CARDOSO E CATURAMA, BAHIA.



LOCAL DE EXECUÇÃO
PARAMIRIM, ÉRICO CARDOSO E
CATURAMA (BA)



EMPRESA CONTRATADA
APLICAR ENGENHARIA LTDA



DATA DO INÍCIO DA EXECUÇÃO (OS)
04/01/2023



VALOR GLOBAL DO CONTRATO
R\$ 1.070.970,09



DURAÇÃO DO PROJETO
26 MESES (1º ADITIVO DE PRAZO)



VALOR EXECUTADO ATÉ AGOSTO
R\$ 961.837,04



NÚMERO DO CONTRATO
064/2022



PRÓXIMAS ETAPAS
MEDIÇÃO 19



FISCAL TÉCNICO APV
PAULO SÉRGIO



**PERCENTUAL
DE EXECUÇÃO**

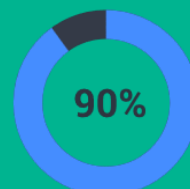

MÉDIO SÃO FRANCISCO



EIXO 5

BIODIVERSIDADE
E REQUALIFICAÇÃO
AMBIENTAL



CONTRATAÇÃO DE PESSOA JURÍDICA PARA EXECUÇÃO DE SERVIÇOS E OBRAS DE REQUALIFICAÇÃO AMBIENTAL NA BACIA DO RIO CORRENTE, NO MUNICÍPIO DE CORRENTINA, BAHIA



LOCAL DE EXECUÇÃO
CORRENTINA (BA)



EMPRESA CONTRATADA
APLICAR ENGENHARIA LTDA



DATA DO INÍCIO DA EXECUÇÃO (OS)
09/07/2024



VALOR GLOBAL DO CONTRATO
R\$ 1.723.842,61



DURAÇÃO DO PROJETO
10 MESES



VALOR EXECUTADO ATÉ AGOSTO
R\$ 65.506,02



NÚMERO DO CONTRATO
022/2024



PRÓXIMAS ETAPAS
MEDIÇÃO 02



FISCAL TÉCNICO APV
PAULO SÉRGIO



PERCENTUAL
DE EXECUÇÃO

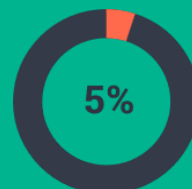

MÉDIO SÃO FRANCISCO



EIXO 5

BIODIVERSIDADE
E REQUALIFICAÇÃO
AMBIENTAL



FISCALIZAÇÃO DE PROJETOS DE REQUALIFICAÇÃO AMBIENTAL NO MÉDIO E SUBMÉDIO SÃO FRANCISCO



LOCAL DE EXECUÇÃO
CORRENTINA E LAPÃO (BA)



EMPRESA CONTRATADA
GAMA ENGENHARIA E RECURSOS
HIDRICOS LTDA



DATA DO INÍCIO DA EXECUÇÃO (OS)
25/06/2024



VALOR GLOBAL DO CONTRATO
R\$ 1.000.120,70



DURAÇÃO DO PROJETO
17 MESES



VALOR EXECUTADO ATÉ AGOSTO
R\$ 100.812,17



NÚMERO DO CONTRATO
023/2024



PRÓXIMAS ETAPAS
MEDIÇÃO 02



FISCAL TÉCNICO APV
PAULO SÉRGIO



**PERCENTUAL
DE EXECUÇÃO**

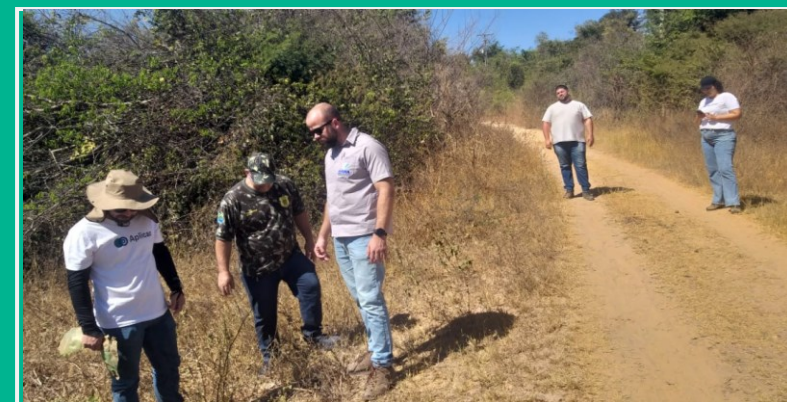

MÉDIO SÃO FRANCISCO



EIXO 5

BIODIVERSIDADE
E REQUALIFICA-
ÇÃO AMBIENTAL



PROJETOS INDIVIDUAIS POR PROPRIEDADE DO PROGRAMA DE PROTEÇÃO, CONSERVAÇÃO E RECUPERAÇÃO AMBIENTAL EM MICROBACIA DO RIO SÃO FRANCISCO – ALTO E MÉDIO SF



LOCAL DE EXECUÇÃO
BOM JESUS DA LAPA E
FORMOSA DO RIO PRETO (BA)



EMPRESA CONTRATADA
EMBAÚBA AMBIENTAL LTDA



DATA DO INÍCIO DA EXECUÇÃO (OS)
28/08/2024



VALOR GLOBAL DO CONTRATO
R\$ 1.956.708,73



DURAÇÃO DO PROJETO
14 MESES



VALOR EXECUTADO ATÉ AGOSTO
R\$ 0,00



NÚMERO DO CONTRATO
046/2024



PRÓXIMAS ETAPAS
1. DIAGNÓSTICO DAS MICROBACIAS E
2. BASES DE DADOS GEOGRÁFICOS
3.



FISCAL TÉCNICO APV
PAULO SÉRGIO



**PERCENTUAL
DE EXECUÇÃO**

0%





NO MÉDIO SÃO FRANCISCO

1. EXECUÇÃO DE VIVEIRO DE MUDAS E SISTEMA DE IRRIGAÇÃO NO MUNICÍPIO DE LAPÃO – BA
2. EXECUÇÃO DO SISTEMA DE ABASTECIMENTO DE ÁGUA DO POVOADO DE CURRALINHO, SÃO GABRIEL/BA
3. ASSESSORAMENTO TÉCNICO NA FISCALIZAÇÃO DE OBRA DE IMPLANTAÇÃO DE SISTEMA DE ABASTECIMENTO DE ÁGUA EM CURRALINHO, SÃO GABRIEL/BA

SUBMÉDIO SÃO FRANCISCO



EIXO 1

GOVERNANÇA E
MOBILIZAÇÃO
SOCIAL



INSTALAÇÕES DE UNIDADE DE APOIO À EDUCAÇÃO AMBIENTAL E CAPACITAÇÃO DE POVOS TRADICIONAIS (UNEB) - JEREMOABO - BA



LOCAL DE EXECUÇÃO
JEREMOABO (BA)



EMPRESA CONTRATADA
AGUARDANDO LICITAÇÃO



DATA DO INÍCIO DA EXECUÇÃO (OS)
AGUARDANDO LICITAÇÃO



VALOR GLOBAL DO CONTRATO
ENTRE R\$ 12 E R\$ 14 MILHÕES



DURAÇÃO DO PROJETO
12 - 18 MESES



VALOR EXECUTADO ATÉ AGOSTO
0,00



NÚMERO DO CONTRATO
NÃO DEFINIDO



PRÓXIMAS ETAPAS
AVALIAÇÃO DO MATERIAL RECEBIDO
PELA UNEB E AGUARDANDO ENVIO DA
PROPOSTA DE CONTRAPARTIDA



FISCAL TÉCNICO APV
THIAGO LANA



PERCENTUAL
DE EXECUÇÃO

0%

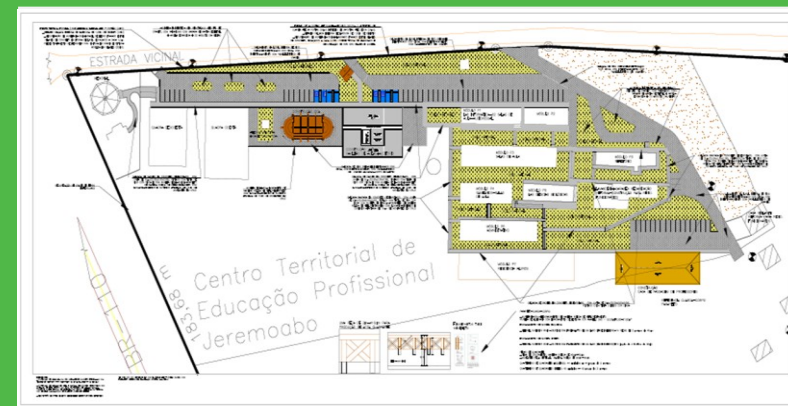

SUBMÉDIO SÃO FRANCISCO



EIXO 2 QUALIDADE DA ÁGUA E SANEAMENTO

CBHSF
COMITÊ DA BACIA HIDROGRÁFICA DO RIO SÃO FRANCISCO

AGÊNCIA
peixe VIVO
Agência de Bacia Hidrográfica

EXECUÇÃO DE SOLUÇÕES INDIVIDUAIS DE TRATAMENTO DE EFLUENTES DOMÉSTICOS NO MUNICÍPIO DE INHAPI/AL



LOCAL DE EXECUÇÃO
ALDEIA KOIUPANKÁ



EMPRESA CONTRATADA
RGA ENGENHARIA LTDA



DATA DO INÍCIO DA EXECUÇÃO (OS)
31/07/2024



VALOR GLOBAL DO CONTRATO
R\$ 1.100.000,00



DURAÇÃO DO PROJETO
08 MESES



VALOR EXECUTADO ATÉ AGOSTO
0,00



NÚMERO DO CONTRATO
039/2024



PRÓXIMAS ETAPAS
1ª MEDIÇÃO SERÁ 01/SET.



FISCAL TÉCNICO APV
GUILHERME CARVALHO



PERCENTUAL
DE EXECUÇÃO

0%



SUBMÉDIO SÃO FRANCISCO



EIXO 2 QUALIDADE DA ÁGUA E SANEAMENTO

CBHSF
COMITÊ DA BACIA HIDROGRÁFICA DO RIO SÃO FRANCISCO

AGÊNCIA
peixe vivo
Agência de Bacia Hidrográfica

EXECUÇÃO DE SOLUÇÕES INDIVIDUAIS DE TRATAMENTO DE EFLUENTES DOMÉSTICOS NO MUNICÍPIO DE PARICONHA/AL



LOCAL DE EXECUÇÃO
ALDEIA DA ETNIA JERIPANKÓ



EMPRESA CONTRATADA
W2 ENGENHARIA LTDA



DATA DO INÍCIO DA EXECUÇÃO (OS)
31/07/2024



VALOR GLOBAL DO CONTRATO
R\$ 4.001.000,00



DURAÇÃO DO PROJETO
14 MESES



VALOR EXECUTADO ATÉ AGOSTO
0,00



NÚMERO DO CONTRATO
040/2024



PRÓXIMAS ETAPAS
1ª MEDIÇÃO SERÁ 01/SET.



FISCAL TÉCNICO APV
GUILHERME CARVALHO



PERCENTUAL DE EXECUÇÃO

0%



SUBMÉDIO SÃO FRANCISCO



EIXO 2 QUALIDADE DA ÁGUA E SANEAMENTO

CBHSF
COMITÊ DA BACIA HIDROGRÁFICA DO RIO SÃO FRANCISCO

AGÊNCIA
peixe VIVO
Agência de Bacia Hidrográfica

EXECUÇÃO DE SOLUÇÕES INDIVIDUAIS DE TRATAMENTO DE EFLUENTES DOMÉSTICOS NO MUNICÍPIO DE JAGUARARI/BA



LOCAL DE EXECUÇÃO
COMUNIDADE SERRA DOS MORGADOS



EMPRESA CONTRATADA
CONSTRUTORA JOAMAR LTDA



DATA DO INÍCIO DA EXECUÇÃO (OS)

-



VALOR GLOBAL DO CONTRATO
R\$ 2.229.931,84



DURAÇÃO DO PROJETO
13 MESES



VALOR EXECUTADO ATÉ AGOSTO
0,00



NÚMERO DO CONTRATO
044/2024



PRÓXIMAS ETAPAS
EMISSÃO DA O.S.



FISCAL TÉCNICO APV
GUILHERME CARVALHO



PERCENTUAL
DE EXECUÇÃO

0%



SUBMÉDIO SÃO FRANCISCO



EIXO 5

BIODIVERSIDADE
E REQUALIFICA-
ÇÃO AMBIENTAL



CONTRATAÇÃO DE PESSOA JURÍDICA PARA A EXECUÇÃO DO PROJETO DE SUSTENTABILIDADE SOCIOAMBIENTAL NO SEMIÁRIDO EM GLÓRIA – BA: INSTALAÇÃO DE SISTEMAS FOTOVOLTAICOS



LOCAL DE EXECUÇÃO
GLÓRIA (BA)



EMPRESA CONTRATADA
SOLARTERRA ENGENHARIA E
SERVIÇOS LTDA



DATA DO INÍCIO DA EXECUÇÃO (OS)
19/06/2024



VALOR GLOBAL DO CONTRATO
R\$ 1.550.000,00



DURAÇÃO DO PROJETO
11 MESES



VALOR EXECUTADO ATÉ AGOSTO
R\$ 0,00



NÚMERO DO CONTRATO
020/2024



PRÓXIMAS ETAPAS
MEDIÇÃO 02



FISCAL TÉCNICO APV
PAULO SÉRGIO



PERCENTUAL
DE EXECUÇÃO

0%



SUBMÉDIO SÃO FRANCISCO



EIXO 5

BIODIVERSIDADE
E REQUALIFICAÇÃO
AMBIENTAL



FISCALIZAÇÃO DE PROJETOS DE REQUALIFICAÇÃO AMBIENTAL NO MÉDIO E SUBMÉDIO SÃO FRANCISCO



LOCAL DE EXECUÇÃO
GLÓRIA, (BA) FLORESTA (PE) E
CURAÇÁ (BA)



DATA DO INÍCIO DA EXECUÇÃO (OS)
25/06/2024



DURAÇÃO DO PROJETO
17 MESES



NÚMERO DO CONTRATO
023/2024



FISCAL TÉCNICO APV
PAULO SÉRGIO



EMPRESA CONTRATADA
GAMA ENGENHARIA E RECURSOS
HIDRICOS LTDA



VALOR GLOBAL DO CONTRATO
R\$ 1.000.120,70



VALOR EXECUTADO ATÉ AGOSTO
R\$ 100.812,17



PRÓXIMAS ETAPAS
MEDIÇÃO 02

**PERCENTUAL
DE EXECUÇÃO**

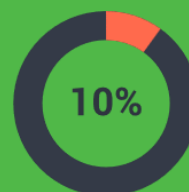

SUBMÉDIO SÃO FRANCISCO



EIXO 5

BIODIVERSIDADE
E REQUALIFICAÇÃO
AMBIENTAL

COMITÊ DA BACIA HIDROGRÁFICA
DO RIO SÃO FRANCISCO

AGÊNCIA
peixe
vivo
Agência de Bacia Hidrográfica

CONTRATAÇÃO DE PESSOA JURÍDICA PARA EXECUÇÃO DE SERVIÇOS E OBRAS DE REQUALIFICAÇÃO AMBIENTAL NA BACIA DO RIO PAJEÚ, NO MUNICÍPIO DE FLORESTA, PERNAMBUCO



LOCAL DE EXECUÇÃO
FLORESTA (PE)



EMPRESA CONTRATADA
W2 ENGENHARIA LTDA



DATA DO INÍCIO DA EXECUÇÃO (OS)
25/07/2024



VALOR GLOBAL DO CONTRATO
R\$ 1.272.689,84



DURAÇÃO DO PROJETO
14 MESES



VALOR EXECUTADO ATÉ AGOSTO
R\$ 137.577,77



NÚMERO DO CONTRATO
037/2024



PRÓXIMAS ETAPAS
MEDIÇÃO 02



FISCAL TÉCNICO APV
PAULO SÉRGIO



PERCENTUAL
DE EXECUÇÃO

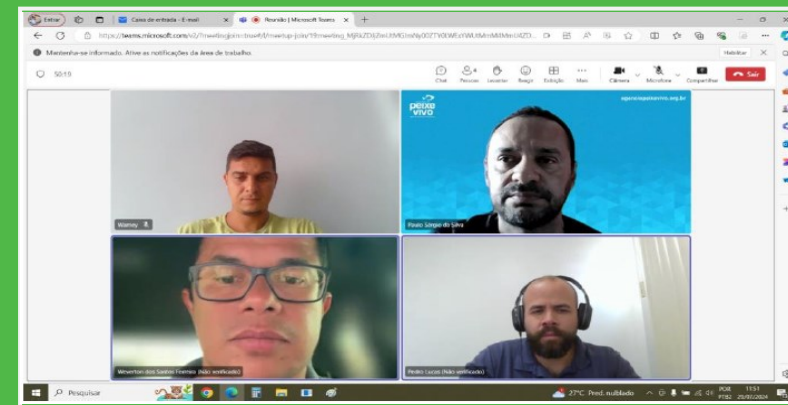

SUBMÉDIO SÃO FRANCISCO



EIXO 5

BIODIVERSIDADE
E REQUALIFICA-
ÇÃO AMBIENTAL



PROJETOS INDIVIDUAIS POR PROPRIEDADE DO PROGRAMA DE PROTEÇÃO, CONSERVAÇÃO E RECUPERAÇÃO AMBIENTAL EM MICROBACIA DO RIO SÃO FRANCISCO – SUBMÉDIO SF E BAIXO SF



LOCAL DE EXECUÇÃO
PETROLÂNDIA (PE) E
PILÃO ARCADEO (BA)



EMPRESA CONTRATADA
ÁGUA E SOLO ESTUDOS E PROJETOS LTDA



DATA DO INÍCIO DA EXECUÇÃO (OS)
28/08/2024



VALOR GLOBAL DO CONTRATO
R\$ 1.805.107,00



DURAÇÃO DO PROJETO
14 MESES



VALOR EXECUTADO ATÉ AGOSTO
R\$ 0,00



NÚMERO DO CONTRATO
050/2024



PRÓXIMAS ETAPAS
1 DIAGNÓSTICO DAS MICROBACIAS E
2 BASES DE DADOS GEOGRÁFICOS
3



FISCAL TÉCNICO APV
PAULO SÉRGIO



**PERCENTUAL
DE EXECUÇÃO**

0%



Aldeia Pankararu Brejinho da Serra -9,12424, BA





NO SUBMÉDIO SÃO FRANCISCO

1. EXECUÇÃO DE OBRAS DE REQUALIFICAÇÃO AMBIENTAL NA BACIA DO RIACHO MOCAMBO, EM CURAÇÁ, BAHIA

BAIXO SÃO FRANCISCO



EIXO 1

GOVERNANÇA E
MOBILIZAÇÃO
SOCIAL



ELABORAÇÃO DE PROJETOS ARQUITETÔNICO, BÁSICO E EXECUTIVO PARA O MUSEU AMBIENTAL “CASA DO VELHO CHICO” NO MUNICÍPIO DE TRAIPU/AL



LOCAL DE EXECUÇÃO
TRAIPU (AL)



EMPRESA CONTRATADA
MÉTRICA ENGENHARIA



DATA DO INÍCIO DA EXECUÇÃO (OS)
23/10/2023



VALOR GLOBAL DO CONTRATO
R\$ 145.997,93



DURAÇÃO DO PROJETO
10 MESES



VALOR EXECUTADO ATÉ AGOSTO
R\$ 145.997,93



NÚMERO DO CONTRATO
041/2023



PRÓXIMAS ETAPAS
ELABORAÇÃO DE TDR PARA
PROJETOS COMPLEMENTARES



FISCAL TÉCNICO APV
THIAGO LANA



PERCENTUAL
DE EXECUÇÃO

100%



BAIXO SÃO FRANCISCO



EIXO 2 QUALIDADE DA ÁGUA E SANEAMENTO



ELABORAÇÃO DE PROJETO BÁSICO E EXECUTIVO PARA INTERVENÇÕES NA CENTRAL DE TRIAGEM E UNIDADE DE TRANSBORDO DE PROPRIÁ - CONBASF



LOCAL DE EXECUÇÃO
PROPRIÁ (SE)



EMPRESA CONTRATADA
MÉTRICA ENGENHARIA EIRELI



DATA DO INÍCIO DA EXECUÇÃO (OS)
18/03/2024 (OS Nº 12/2024)



VALOR GLOBAL DO CONTRATO
R\$ 204.733,81



DURAÇÃO DO PROJETO
07 MESES



VALOR EXECUTADO ATÉ AGOSTO
R\$ 30.719,07



NÚMERO DO CONTRATO
006/2024



PRÓXIMAS ETAPAS
Entrega do projeto básico e do projeto executivo



FISCAL TÉCNICO APV
JOÃO PAULO COIMBRA



PERCENTUAL DE EXECUÇÃO



BAIXO SÃO FRANCISCO



EIXO 2 QUALIDADE DA ÁGUA E SANEAMENTO



ELABORAÇÃO DE PROJETO BÁSICO E EXECUTIVO PARA GALPÕES DE TRIAGEM E PÁTIOS DE COMPOSTAGEM - CONBASF



LOCAL DE EXECUÇÃO

CANINDÉ DE SÃO FRANCISCO, CAPELA, MONTE ALEGRE DE SERGIPE, NEÓPOLIS, TELHA (SE)



EMPRESA CONTRATADA EM LICITAÇÃO



DATA DO INÍCIO DA EXECUÇÃO (OS) NÃO EMITIDA



VALOR MÁXIMO GLOBAL DO TDR R\$ 1.325.505,94



DURAÇÃO DO PROJETO 12 MESES



VALOR EXECUTADO ATÉ AGOSTO R\$ 0,00



ATO CONVOCATÓRIO 023/2024



PRÓXIMAS ETAPAS

Em licitação (prazo para propostas é 23/08/2024)



FISCAL TÉCNICO APV JOÃO PAULO COIMBRA



PERCENTUAL DE EXECUÇÃO



BAIXO SÃO FRANCISCO



EIXO 2 QUALIDADE DA ÁGUA E SANEAMENTO



EXECUÇÃO DE OBRAS E SERVIÇOS PARA A INTERLIGAÇÃO DA REDE DE ESGOTO SANITÁRIO DO CENTRO HISTÓRICO DE PENEDO/AL COM A ETE EXISTENTE



LOCAL DE EXECUÇÃO
PENEDO (AL)



EMPRESA CONTRATADA
W2 ENGENHARIA LTDA



DATA DO INÍCIO DA EXECUÇÃO (OS)
21/11/2023



VALOR GLOBAL DO CONTRATO
R\$ 2.100.000,00



DURAÇÃO DO PROJETO
11 MESES



VALOR EXECUTADO ATÉ AGOSTO
R\$ 441.228,08



NÚMERO DO CONTRATO
035/2023



PRÓXIMAS ETAPAS
CONTRATO SUSPENSO
RETOMADA DAS OBRAS PREVISTA
PARA SETEMBRO



FISCAL TÉCNICO APV
THIAGO LANA



PERCENTUAL DE EXECUÇÃO

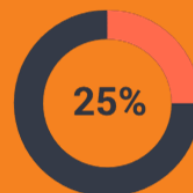

BAIXO SÃO FRANCISCO



EIXO 2

QUALIDADE
DA ÁGUA E
SANEAMENTO



ASSESSORAMENTO TÉCNICO NA FISCALIZAÇÃO DE OBRA DA REDE DE ESGOTAMENTO SANITÁRIO DO CENTRO HISTÓRICO DE PENEDO/AL



LOCAL DE EXECUÇÃO
PENEDO(AL)



FISCAL CONTRATADO
THIAGO BARBOSA



DATA DO INÍCIO DA EXECUÇÃO (OS)
27/11/2023



VALOR GLOBAL DO CONTRATO
R\$ 153.120,00



DURAÇÃO DO PROJETO
10 MESES



VALOR EXECUTADO ATÉ AGOSTO
R\$ 153.120,00



NÚMERO DO CONTRATO
053/2023



PRÓXIMAS ETAPAS
PROVÁVEL ADITIVO CONTRATUAL



FISCAL TÉCNICO APV
THIAGO LANA



PERCENTUAL
DE EXECUÇÃO

100%

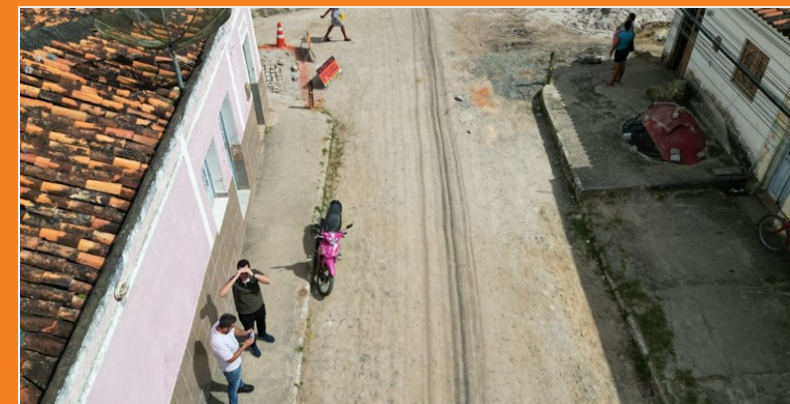

BAIXO SÃO FRANCISCO



EIXO 2

QUALIDADE
DA ÁGUA E
SANEAMENTO



EXECUÇÃO DE SOLUÇÕES INDIVIDUAIS DE TRATAMENTO DE EFLUENTES DOMÉSTICOS NO MUNICÍPIO DE TRAIPU/AL



LOCAL DE EXECUÇÃO
QUILOMBO LAGOÁ DO TABULEIRO



EMPRESA CONTRATADA
APLICAR ENGENHARIA LTDA



DATA DO INÍCIO DA EXECUÇÃO (OS)
NÃO EMITIDA



VALOR GLOBAL DO CONTRATO
R\$ 2.969.000,00



DURAÇÃO DO PROJETO
15 MESES



VALOR EXECUTADO ATÉ AGOSTO
R\$ 0,00



NÚMERO DO CONTRATO
042/2024



PRÓXIMAS ETAPAS
EMISSÃO DE O.S.



FISCAL TÉCNICO APV
GUILHERME CARVALHO



**PERCENTUAL
DE EXECUÇÃO**

0%



BAIXO SÃO FRANCISCO



EIXO 2

QUALIDADE
DA ÁGUA E
SANEAMENTO



EXECUÇÃO DE SOLUÇÕES INDIVIDUAIS DE TRATAMENTO DE EFLUENTES DOMÉSTICOS NO MUNICÍPIO DE SANTANA DO IPANEMA/AL



LOCAL DE EXECUÇÃO
QUILOMBO BAIXIO DO TAMANDUÁ
E POVOADO DE ÓLEO



EMPRESA CONTRATADA
RGA ENGENHARIA LTDA



DATA DO INÍCIO DA EXECUÇÃO (OS)
23/08/2024



VALOR GLOBAL DO CONTRATO
R\$ 2.513.000,00



DURAÇÃO DO PROJETO
15 MESES



VALOR EXECUTADO ATÉ AGOSTO
R\$ 0,00



NÚMERO DO CONTRATO
043/2024



PRÓXIMAS ETAPAS
1ª MEDIÇÃO SERÁ 01/SET.



FISCAL TÉCNICO APV
GUILHERME CARVALHO



**PERCENTUAL
DE EXECUÇÃO**



BAIXO SÃO FRANCISCO



EIXO 2

QUALIDADE
DA ÁGUA E
SANEAMENTO



EXECUÇÃO DE SOLUÇÕES INDIVIDUAIS DE TRATAMENTO DE EFLUENTES DOMÉSTICOS NO MUNICÍPIO DE PEDRO ALEXANDRE/BA



LOCAL DE EXECUÇÃO
BARREIRAS, PEDRO ALEXANDRE - BA



EMPRESA CONTRATADA
CONSTRUTORA JOAMAR LTDA



DATA DO INÍCIO DA EXECUÇÃO (OS)
NÃO EMITIDA



VALOR GLOBAL DO CONTRATO
R\$ 3.046.809,26



DURAÇÃO DO PROJETO
14 MESES



VALOR EXECUTADO ATÉ AGOSTO
R\$ 0,00



NÚMERO DO CONTRATO
045/2024



PRÓXIMAS ETAPAS
EMISSÃO DA O.S.



FISCAL TÉCNICO APV
GUILHERME CARVALHO



**PERCENTUAL
DE EXECUÇÃO**

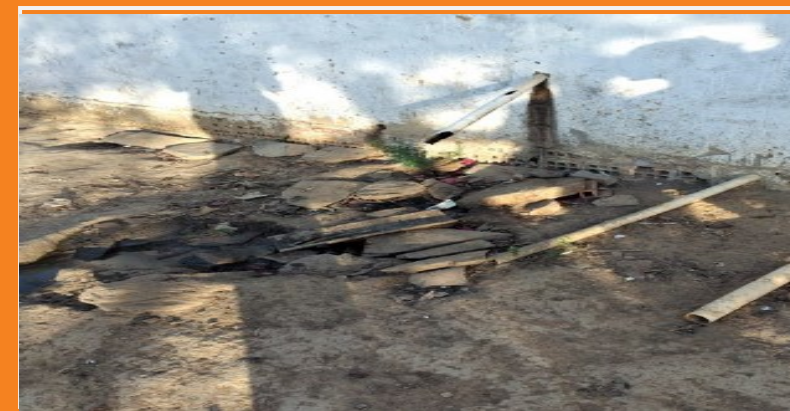

BAIXO SÃO FRANCISCO



EIXO 3

QUANTIDADE DE
ÁGUA E USOS
MÚLTIPLOS



LEVANTAMENTO DE USOS DE RECURSOS HÍDRICOS NO RIO SÃO FRANCISCO, DA JUSANTE DE PAULO AFONSO ATÉ A FOZ, POR MEIO DE AEROFOTOGRAFIA E PERFILAMENTO A LASER



LOCAL DE EXECUÇÃO
PERNAMBUCO, ALAGOAS E SERGIPE



EMPRESA CONTRATADA
SERVIÇOS AÉREOS INDUSTRIAIS
ESPECIALIZADOS LTDA



DATA DO INÍCIO DA EXECUÇÃO (OS)
23/05/2024



VALOR GLOBAL DO CONTRATO
R\$ 282.000,00



DURAÇÃO DO PROJETO
08 MESES



VALOR EXECUTADO ATÉ AGOSTO
R\$ 28.200,00



NÚMERO DO CONTRATO
012/2024



PRÓXIMAS ETAPAS
EXECUÇÃO DOS VOOS E ENTREGA
DE ARQUIVOS BRUTOS



FISCAL TÉCNICA APV
FLÁVIA MENDES



**PERCENTUAL
DE EXECUÇÃO**

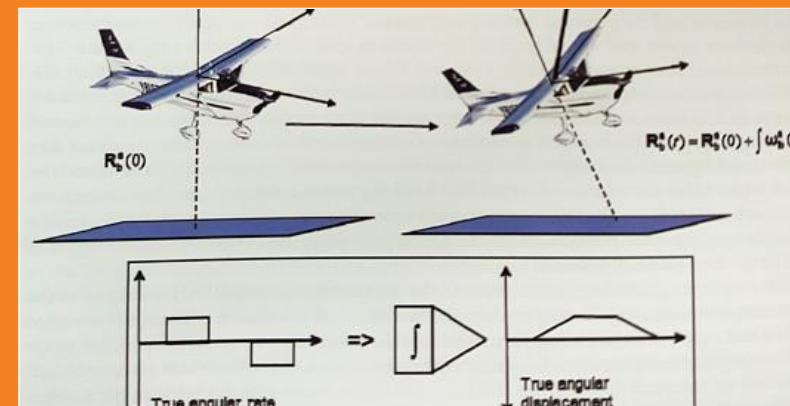

BAIXO SÃO FRANCISCO



EIXO 5

BIODIVERSIDADE
E REQUALIFICAÇÃO
AMBIENTAL



EXECUÇÃO DE SERVIÇOS DE MELHORIAS DA MACRODRENAGEM EM ESTRADAS VICINAIS NA ALDEIA XOKÓ, PORTO DA FOLHA - SE



LOCAL DE EXECUÇÃO
ALDEIA XOKÓ



EMPRESA CONTRATADA
RGA ENGENHARIA EIRELLI



DATA DO INÍCIO DA EXECUÇÃO (OS)
03/06/2024



VALOR GLOBAL DO CONTRATO
R\$ 3.341.177,17



DURAÇÃO DO PROJETO
10 MESES



VALOR EXECUTADO ATÉ AGOSTO
R\$ 759.750,85



NÚMERO DO CONTRATO
013/2024



PRÓXIMAS ETAPAS
MEDIÇÃO 03



FISCAL TÉCNICO APV
GUILHERME CARVALHO



PERCENTUAL
DE EXECUÇÃO

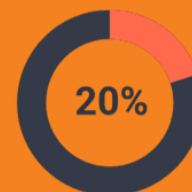

BAIXO SÃO FRANCISCO



EIXO 5

BIODIVERSIDADE
E REQUALIFICAÇÃO
AMBIENTAL



ASSESSORAMENTO TÉCNICO NA FISCALIZAÇÃO DE OBRA DE SERVIÇOS DE MELHORIAS DA MACRODRENAGEM NA ALDEIA XOKÓ, PORTO DA FOLHA – SE



LOCAL DE EXECUÇÃO
ALDEIA XOKÓ



FISCAL CONTRATADO
RODRIGO LESSA GOMES



DATA DO INÍCIO DA EXECUÇÃO (OS)
16/07/2024



VALOR GLOBAL DO CONTRATO
R\$ 107.640,00



DURAÇÃO DO PROJETO
10 MESES



VALOR EXECUTADO ATÉ AGOSTO
R\$ 13.455,00



NÚMERO DO CONTRATO
028/2024



PRÓXIMAS ETAPAS
Produto 03



FISCAL TÉCNICO APV
GUILHERME CARVALHO



PERCENTUAL
DE EXECUÇÃO



BAIXO SÃO FRANCISCO



EIXO 5

BIODIVERSIDADE
E REQUALIFICAÇÃO
AMBIENTAL



PROJETOS INDIVIDUAIS POR PROPRIEDADE DO PROGRAMA DE PROTEÇÃO, CONSERVAÇÃO E RECUPERAÇÃO AMBIENTAL EM MICROBACIA DO RIO SÃO FRANCISCO – SUBMÉDIO SF E BAIXO SF



LOCAL DE EXECUÇÃO
JAPARATUBA E NOSSA SENHORA DA GLÓRIA (SE)



EMPRESA CONTRATADA
ÁGUA E SOLO ESTUDOS E PROJETOS LTDA



DATA DO INÍCIO DA EXECUÇÃO (OS)
28/08/2024



VALOR GLOBAL DO CONTRATO
R\$ 1.805.107,00



DURAÇÃO DO PROJETO
14 MESES



VALOR EXECUTADO ATÉ AGOSTO
R\$ 0,00



NÚMERO DO CONTRATO
050/2024



PRÓXIMAS ETAPAS
1 DIAGNÓSTICO DAS MICROBACIAS E
2 BASES DE DADOS GEOGRÁFICOS
3



FISCAL TÉCNICO APV
PAULO SÉRGIO



**PERCENTUAL
DE EXECUÇÃO**

0%





NO BAIXO SÃO FRANCISCO

1. PERÍCIA PARA AVALIAÇÃO DA ESTABILIDADE DO SISTEMA DE RESERVAÇÃO DE ÁGUA BRUTA NO MUNICÍPIO DE PIAÇABUÇU/AL
2. PROJETOS COMPLEMENTARES EXECUTIVOS PARA O MUSEU VELHO CHICO EM TRAIPI (AL)
3. REALIZAÇÃO DE SERVIÇOS DE MONITORAMENTO DA QUALIDADE DA ÁGUA NO BAIXO CURSO DO RIO SÃO FRANCISCO

EXPEDIENTE

CBH DO RIO SÃO FRANCISCO

José Maciel Nunes de Oliveira
Presidente

Marcus Vinícius Polignano
Vice-presidente

Almacks Luiz Carneiro da Silva
Secretário

Altino Rodrigues Neto
Coordenador da CCR Alto São Francisco

Ednaldo de Castro Campos
Coordenador da CCR Médio São Francisco

Cláudio Ademar da Silva
Coordenador da CCR Submédio São Francisco

Anivaldo Miranda Pinto
Coordenador da CCR Baixo São Francisco

AGÊNCIA PEIXE VIVO

Gustavo Henrique Costa Simões
Presidente do Conselho de Administração

Rúbia Santos Barbosa Mansur
**Diretora Geral Interina e
Gerente de Integração**

Berenice Coutinho Malheiros dos Santos
Gerente de Administração e Finanças

Jacqueline Evangelista Fonseca
Gerente de Projetos Interina

Taís Passos Guimarães
Gerente de Gestão Estratégica Interina

Daniel Alexandre de Brito
**Analista de comunicação
Produção, projeto gráfico e revisão final**

João Paulo Paulino Coimbra
**Coordenador Técnico
Produção e revisão final**

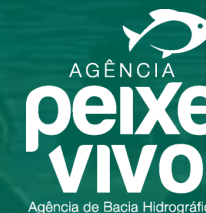

COMITÊ DA BACIA HIDROGRÁFICA DO RIO SÃO FRANCISCO

Av. Dr. Antônio Gomes de Barros, nº 625, sala 211, Edf. The Square Park Office, Jatiúca, Maceió/AL - CEP 57.036-000
www.cbhsaofrancisco.org.br | [@cbhsaofrancisco](https://www.instagram.com/cbhsaofrancisco)

AGÊNCIA PEIXE VIVO

Rua dos Carijós, 166 – 5º andar – Centro,
Belo Horizonte (MG) - CEP 30.120-060
www.agenciapeixevivo.org.br | [@agenciapeixevivo](https://www.instagram.com/agenciapeixevivo)



COMITÊ DA BACIA HIDROGRÁFICA DO RIO SÃO FRANCISCO

Av. Dr. Antônio Gomes de Barros, nº 625, sala 211, Edf. The Square Park Office, Jatiúca, Maceió/AL - CEP 57.036-000
www.cbhsaofrancisco.org.br | [@cbhsaofrancisco](https://www.instagram.com/cbhsaofrancisco)

AGÊNCIA PEIXE VIVO

Rua dos Carijós, 166 – 5º andar – Centro,
Belo Horizonte (MG) - CEP 30.120-060
www.agenciapeixevivo.org.br | [@agenciapeixevivo](https://www.instagram.com/agenciapeixevivo)